



OUTBACK POWER OPEN LOOP CONFIGURATION WITH DISCOVER LITHIUM BATTERIES

READ AND SAVE THESE INSTRUCTIONS

- INTRODUCTION 3**
- 1. AUDIENCE, WARNINGS, MESSAGES, GENERAL SAFETY, PERSONAL PROTECTIVE EQUIPMENT ... 3**
 - 1.1 Audience. 3
 - 1.2 Warning, Caution, Notice, and Note Messages. 3
 - 1.3 General Warnings 4
 - 1.4 Safe Handling Procedures. 4
 - 1.5 Personal Protective Equipment. 5
- 2. DOCUMENTATION 5**
- 3. OVERVIEW 6**
 - 3.1 System Overview. 6
 - 3.2 Minimum Battery System Capacity 7
- 4. CONFIGURATION 8**
 - 4.1 MATE3 / MATE3S Main Menu. 8
 - 4.2 MATE3 / MATE3S Menu Map 8
 - 4.3 OutBack Radian Inverter Settings 9
 - 4.4 Charge Controller Settings 9
 - 4.5 FLEXnet Battery Monitor Settings 10
 - 4.5.1 FN-DC Calibration 10
 - 4.6 Optimizing LBCO Function with MATE3 Controller. 11
 - 4.7 Settings for MATE3 and MATE3s SOC Warnings. 12
- APPENDIX 13**
 - A1. LYNK II: Overview 13
 - A2. Installing and Connecting LYNK II to Batteries 14

INTRODUCTION

This document describes how to set up OutBack Power inverter-chargers to create an open-loop charge configuration with AES LiFePO₄ batteries or AES RACKMOUNT battery modules.

1. AUDIENCE, WARNINGS, MESSAGES, GENERAL SAFETY, PERSONAL PROTECTIVE EQUIPMENT

1.1 Audience

Configuration, installations, service, and operating tasks should only be performed by qualified personnel in consultation with local authorities having jurisdiction and authorized dealers. Qualified personnel should have training, knowledge, and experience in the:

- Installation of electrical equipment
- Application of electrical codes, safety, and installation standards
- Analysis and reduction of hazards involved in performing electrical work
- Installation and configuration of batteries
- Installation and configuration of systems activated by relays

1.2 Warning, Caution, Notice, and Note Messages

Messages in this manual are formatted according to this structure.



Additional information concerning important procedures and features of the product. Read all the instructions before installation, operation, and maintenance.



Important information regarding hazardous conditions.

⚠ WARNING

Important information regarding hazardous conditions that may result in personal injury or death.

⚠ CAUTION

Important information regarding hazardous conditions that may result in personal injury.

NOTICE

Important information regarding conditions that may damage the equipment but not result in personal injury.

NOTE

Ad hoc information concerning important procedures and features unrelated to personal injury or equipment damage.

1.3 General Warnings

WARNING

ELECTRIC SHOCK AND FIRE HAZARD

- This equipment must only be installed as specified.
- Do not disassemble or modify the battery.
- If the battery case has been damaged, do not touch exposed contents.
- There are no user-serviceable parts inside.

Failure to follow these instructions may result in death or serious injury.

WARNING

ELECTRIC SHOCK AND FIRE HAZARD

Do not lay tools or other metal parts on the battery or across the terminals.

Failure to follow these instructions may result in death or serious injury.

CAUTION

ELECTRIC SHOCK

- Do not touch the energized surfaces of any electrical component in the battery system.
- Before servicing the battery, follow all procedures to fully de-energize the battery system.
- Follow the “Safe Handling Procedures” below when working with the battery.

Failure to follow these instructions may result in injury.

1.4 Safe Handling Procedures

Before using the battery and any power electronics, read all instructions and cautionary markings on all components and appropriate sections of their manuals.

- Use personal protective equipment when working with batteries.
- Do not dispose of the battery in a fire.
- Promptly dispose of or recycle used batteries following local regulations.
- Do not disassemble, open, crush, bend, deform, puncture, or shred.
- Do not modify, re-manufacture, or attempt to insert foreign objects into the battery, immerse or expose the battery to water or other liquids, fire, explosion, or other hazards. If the user suspects damage to the battery module due to water, heat, or other reason, take it to a service center for inspection.
- Only use the battery for the system for which it is specified.
- Do not lift or carry the battery while in operation.
- When lifting a heavy battery, follow the appropriate standards.
- Only lift, move, or mount following local regulations.
- Take care when handling battery terminals and cabling.
- Only use the battery with a charging system that meets specifications. Using a battery or charger that does not meet specifications may present a risk of fire, explosion, leakage, or other hazards.

- Do not short-circuit a battery or allow metallic conductive objects to contact battery terminals.
- Replace the battery only with another battery that has been qualified for the system. Using an unqualified battery may present a risk of fire, explosion, leakage, or other hazards.
- Do not drop the device or battery. If the device or battery is dropped, especially on a hard surface, and the user suspects damage, take it to a service center for inspection.

1.5 Personal Protective Equipment

When handling or working near a battery:

- Use Personal Protective Equipment, including clothing, glasses, insulated gloves, and boots.
- Do not wear rings, watches, bracelets, or necklaces.

2. DOCUMENTATION

This Application Note provides information about the integration of Discover Lithium Batteries with OutBack Power inverter-chargers in an open-loop configuration.

Before installation and configuration, consult the relevant product documentation, including Manuals, Application Notes, Installation and Configuration Guides.

OutBack Power Documentation

- MATE3 and MATE3s Programming Guides
- Radian Series Inverter/Charger GS4048A/GS8048A Installation Manual (900-0160-01-01 Rev C)
- Radian Series Inverter/Charger GS4048A/GS8048A Operator's Manual (900-0161-01-01 Rev C)

Visit <https://www.outbackpower.com/> for the most recent version of published documents.

Discover Energy Systems Documentation

- [AES 42-48-6650 LiFePO4 Installation and Operation Manual](#) (805-0065)
- [AES LiFePO4 datasheet](#) (808-0004)
- [AES RACKMOUNT Installation and Operation Manual](#) (805-0043)
- [AES RACKMOUNT datasheet](#) (808-0039)
- [LYNK II Installation and Operation Manual](#) (805-0033)

Visit <https://www.discoverlithium.com> for the most recent version of published documents.

3. OVERVIEW

This manual provides general settings and is not a comprehensive guide to the programming and configuration of a specific installation. An installation may have unique conditions or use cases that require modification or adaptations. Installers must be capable of reviewing and adapting to the specifics of an installation and its specific use case and optimizing settings where needed.

3.1 System Overview

The key steps required to install and configure the Discover Lithium batteries and power conversion equipment are as follows:

- Review and confirm equipment compatibility and correct sizing.
- Terminate all networks correctly.
- Set up the open-loop configuration parameters such as charge and discharge settings on the power conversion equipment.
- Set up user preferences and enable the use case using the power conversion control system.

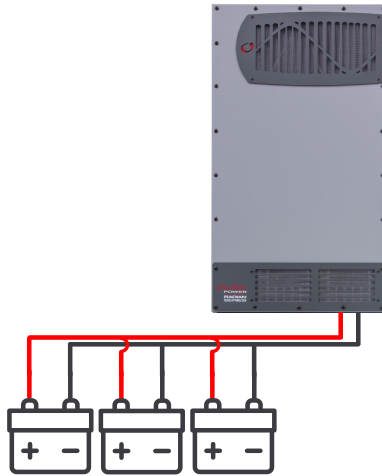

Figure 1. System Overview

Discover Lithium Batteries

- AES LiFePO₄: 42-48-6650
- AES RACKMOUNT: 48-48-5120, 48-48-5120-H

OutBack Power Inverter-Charger

- GS8048A

NOTE

LYNK II Communication Gateway

- The LYNK II communication gateway is not required in an open-loop configuration. However, it is a useful tool to diagnose the battery. For example, by connecting the LYNK II to the battery, you can access the battery logs, which can be used to confirm if the inverter charge settings are fully charging the battery.
- As another example, use the relays on the LYNK for automatically starting a generator, load shedding, load enabling, and turning equipment or warning lights ON/OFF.

3.2 Minimum Battery System Capacity

Battery charge and discharge rates are managed automatically by the Discover Lithium Battery and OutBack Power device. Using large solar arrays with battery banks that are too small can exceed the operating limits of the battery to charge and possibly lead to the BMS triggering over-current protection. Battery capacity must accept the maximum charge current of the system, or charging must be curtailed below the operating limit of the installed batteries. Derive this value by adding together the charge capacities of all inverter-chargers and solar charge controllers in the system. Additionally, battery peak capacity must support the surge requirements demanded by the load attached to the inverter-charger. Match all inverter-charger peak power values with the sum of all battery peak battery current values.

$$\text{Inverter Peak} = (\text{Inverter Surge Value}) / (\text{Inverter Efficiency}) / (48\text{V: Low Battery Cut-Off})$$

Model	Instantaneous Power (100 ms) ⁽¹⁾	Inverter Surge (5 seconds) ⁽¹⁾	Max Continuous Charge	Max Continuous Discharge	AES LiFePO ₄ 42-48-6650 Minimum per inverter ⁽³⁾	AES RACKMOUNT 48-48-5120/48-48-5120-H Minimum per inverter ⁽⁴⁾
GS8048A	16970 VA	12000 VA	115 ADC	154 ADC ⁽²⁾	2	2

⁽¹⁾ Data as published in OutBack Power Radian A Series datasheet (# 980-00076-01-001 REV C, 03/2021).

⁽²⁾ Calculated based on the continuous power (8,000 VA) and efficiency CEC (92.5%) as published in OutBack Power Radian A Series datasheet (# 980-00076-01-001 REV C, 03/2021).

⁽³⁾ Discover AES LiFePO₄ 42-48-6650 Battery, Peak Power: 300 A (3 seconds), 130 A DC Continuous Charge/Discharge, as published in Discover LiFePO₄ 42-48-6650 Installation and Operation Manual (805-0065 Rev A).

⁽⁴⁾ Discover AES RACKMOUNT 48-48-5120/48-48-5120-H Battery, Peak Power: 218 A RMS (3 seconds), 95 A DC Continuous Charge/Discharge (1 hour), as published in Discover AES RACKMOUNT Installation and Operation Manual (805-0043 Rev E).

4. CONFIGURATION

⚠ CAUTION

ELECTRIC SHOCK HAZARD

- Do not use the OutBack Remote Temperature Sensor (RTS) with Discover Lithium batteries.
- Instead of the Remote Temperature Sensor, the BMS on the Discover Lithium battery provides the voltage, temperature, and other readings through the LYNK II communication gateway. Refer to [A1. LYNK II: Overview](#).

Failure to follow these instructions may result in injury.

4.1 MATE3 / MATE3S Main Menu

The charge and discharge settings for AES batteries in an open-loop configuration can be set up manually through the Main Menu of the MATE3(s) Display. To gain access to the Main Menu a password is required.

1. From the home screen, press the LOCK key to bring up the 'Enter Password' screen.
2. Rotate the Control Wheel until the display shows the number 141.
3. Press the Center Button to accept the password.

4.2 MATE3 / MATE3S Menu Map

The following identifies menu items that may require configuration for the battery bank.

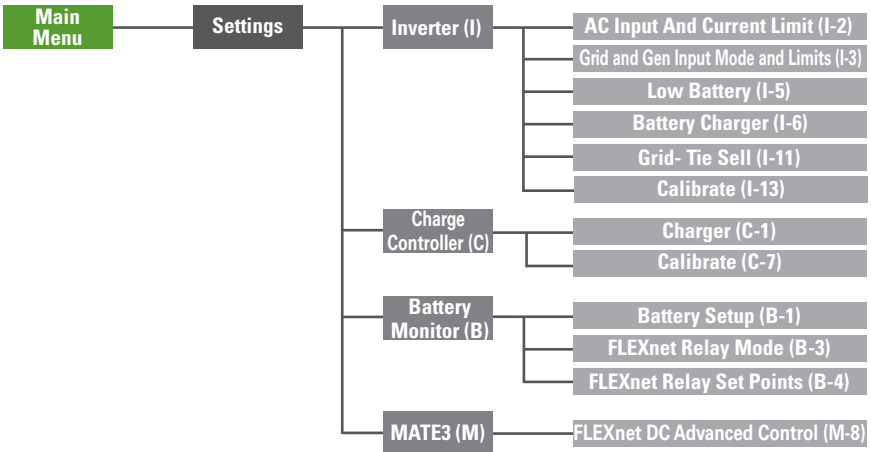

4.3 OutBack Radian Inverter Settings

Inverter Settings	MATE3 Menu	AES LiFePO ₄ 42-48-6650	AES RACKMOUNT 48-48-5120 / 48-48-5120-H
Absorb Voltage	I-6	55.2 V	
Absorb Time ⁽¹⁾	I-6	0.5 to 3.0 hours	
Float Voltage ⁽²⁾	I-6	53.6 V	
Float Time	I-6	Disable, Time = 0	
Re-Float Voltage	I-6	Disabled (50V used as default value)	
Re-Bulk Voltage	I-6	50.4 V	
AC Input Mode	I-3	Adjust as needed	
Grid-Tie - Sell Voltage	I-11	53.2 V	
Charger AC Limit per installed battery	I-2	29 A @ 240 V 58 A @ 120 V	
Low Battery Cut-Out Voltage	I-5	48 V	
Low Battery Cut-Out Delay ⁽³⁾	I-5	5 seconds	
Low Battery Cut-In Voltage	I-5	51.2 V	
High Battery Cut-Out Voltage	I-5	58.4 V	
High Battery Cut-Out Delay ⁽³⁾	I-5	5 seconds	
Calibrate	I-13	(4)	

⁽¹⁾ Under lightly loaded conditions, power charging devices may not regulate their voltage well and may cause voltage fluctuations that rise above the battery operating limits. The recommended minimum Absorb time is 0.5 hour, and up to 3.0 hours for larger battery banks. 1.5 hours is recommended for two AES LiFePO₄ or AES RACKMOUNT batteries.

⁽²⁾ Set Float Voltage as a precautionary default prior to disabling Float Time.

⁽³⁾ Not available with MATE3 Controller.

⁽⁴⁾ Calibrate the voltage readings on the Inverter to match the voltage measured with a voltmeter on the battery terminals.

4.4 Charge Controller Settings

Charge Controller Settings (C)	MATE3(s) Menu	AES LiFePO ₄ 42-48-6650	AES RACKMOUNT 48-48-5120 / 48-48-5120-H
Absorb Voltage ⁽¹⁾	C-1	55.6 V	
Absorb Time ^{(2) (3)}	C-1	0.5 < 3.0 hour	
Float Voltage ⁽¹⁾	C-1	54.0 V	
Re-bulk Voltage	C-1	50.4 V	
Current Limit per installed battery	C-1	130 A	95 A
Absorb End Amps ⁽⁴⁾	C-1	3.25 A	2.5 A
Calibrate	C-7	(5)	

- (1) To prioritize charging from the charge controller, set the Charge Controller Absorb and Float voltages at 0.4 Vdc higher than the inverter settings.
- (2) Under lightly loaded conditions, power charging devices may not regulate their voltage well and may cause voltage fluctuations that rise above the battery operating limits. The recommended minimum Absorb time is 0.5 hour, and up to 3.0 hours for larger battery banks. 1.5 hours is recommended for two AES LiFePO₄ or AES RACKMOUNT batteries.
- (3) Charge controllers will turn off nightly due to the absence of the sun acting as a natural ending for Absorb Time.
- (4) If there is more than one controller, set to 0.
- (5) Calibrate the voltage readings on the Charge Controller to match the voltage measured with a voltmeter on the battery terminals.

4.5 FLEXnet Battery Monitor Settings

FLEXnet Settings (B)	MATE3(s) Menu	AES LiFePO ₄ 42-48-6650	AES RACKMOUNT 48-48-5120 / 48-48-5120-H
Battery Amps-hours per installed battery	B-1	130 Ah	100 Ah
Charged Voltage	B-1	55.2 V, 1.0 min	
Charged Return Amps	B-1	6.5 A	
Charge Factor	B-1	98 %	

4.5.1 FN-DC Calibration

The following describes how to calibrate a FLEXnet DC (FN-DC) battery monitor that is already installed in a system. The system should already set up with a MATE3-class system display, HUB communications manager, inverter, and/or charge controller. This procedure requires a digital multi-meter (DMM) and a slot screwdriver.

⚠ CAUTION

ELECTRIC SHOCK HAZARD

- Follow all safety precautions when working with energized equipment.
- Use Personal Protective Equipment, including clothing, glasses, insulated gloves, and boots.

Failure to follow these instructions may result in injury.

1. **Ensure the battery bank is fully charged.**
2. De-energize system.
3. Remove the FN-DC.
 - Maintain all wired connections (including the green communication cable to the HUB).
4. Place the FN-DC so the informational sticker is facing up and the terminal block is facing away.
5. Press the two push-tabs and remove the FN-DC front cover.
6. Remove the red sealant from the trim pot for the battery (R83).

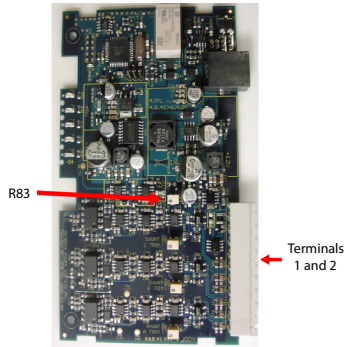

Figure 2. FN-DC with cover removed

7. Energize the system.
8. Use the DMM to measure the battery voltage at terminals 1 and 2 on FN-DC inputs.
9. Read the battery voltage from the MATE3 battery screen (visible by pressing the BATTERY soft key).



Figure 3. MATE3 - BATTERY soft key

10. Use the slot screwdriver to adjust the trim pot (R83) until the displayed voltage of the FN-DC in the MATE3 display matches the measured battery voltage (measure using the DMM between terminals 1 and 2).
11. Replace the front cover.
12. Replace the FN-DC back into the system.

4.6 Optimizing LBCO Function with MATE3 Controller

NOTE

For a more accurate Low-Battery Cut Out (LBCO), use the battery SOC relay on the LYNK II communication gateway. Refer to [A1. LYNK II: Overview](#).

Using a MATE3s controller allows for control over the LBCO delay and should be set up using the parameters noted. However, if a MATE3 controller is used, the inverter's Low Battery Cut-Out timer (5 minute minimum) is not optimized for use with heavy inverter surge loads and a lithium battery. Use the set up outlined below to manage the system when using a MATE3 controller.

FLEXnet Settings (B)	MATE3 Menu	AES LiFePO ₄ 42-48-6650	AES RACKMOUNT 48-48-5120 / 48-48-5120-H
Relay Mode - Invert Logic	B-3	No	
Relay Set Points - Voltage	B-4	High = 53.0 V Low = 49.6 V	
Relay Set Points - SOC	B-4	High = 0% Low = 0%	
Relay Set Points - Delay	B-4	High = 1 Low = 0	

This timer may prevent the inverter low battery cut-out from occurring before the battery BMS self-protects and shuts the battery down.

To avoid this situation, use the relay contacts on the FLEXnet DC Battery Monitor to trigger the low voltage cut-out. Connect the relay contacts to the INVERTER ON/OFF terminals. Once the relay is triggered, the inverter is set to OFF and prevents the battery from being discharged below the battery BMS protection voltage. Refer to section [4.5 FLEXnet Battery Monitor Settings](#) for the recommended settings.

Connect the FLEXnet DC Battery Monitor relay contacts to the inverter as follows.

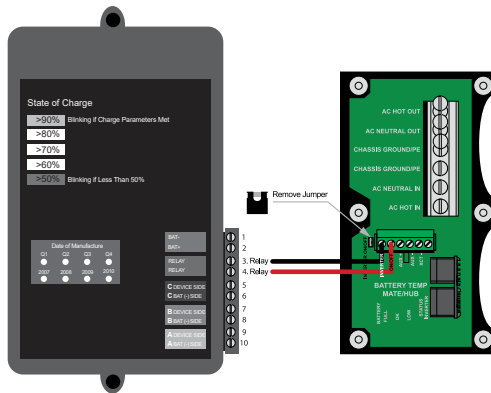

Figure 4. FLEXnet relay contacts connected to the inverter

4.7 Settings for MATE3 and MATE3s SOC Warnings

MATE3(s) Settings (M)	MATE3(s) Menu	AES LiFePO ₄ 42-48-6650	AES RACKMOUNT 48-48-5120 / 48-48-5120-H
FLEXnet DC Advanced - Low SOC Warning Level	M-8	15%	
FLEXnet DC Advanced - Critical SOC Warning Level	M-8	10%	

APPENDIX

A1. LYNK II: Overview

Although mainly used in closed-loop systems, the LYNK II has other features that may be of use in an open-loop charging system.

- LED on the LYNK II visually displays the battery SOC in 20% increments.



Figure 5. Battery SOC - illustration shows SOC between 41% and 60%

- The LYNK II enables access to the battery logs, which record various events involving the battery. The battery log includes battery cell voltage, cell temperature, and charge current, which is useful for troubleshooting and calibrating the charge settings.
- Relays on the LYNK II turn ON/OFF based on various conditions on the battery. You can use them for automatically starting a generator, load shedding, load enabling, and turning equipment or warning lights ON/OFF. Configure the LYNK II with the LYNK ACCESS software, which runs on Windows operating systems only.
- LYNK II and LYNK ACCESS provide information about each battery in the battery bank.

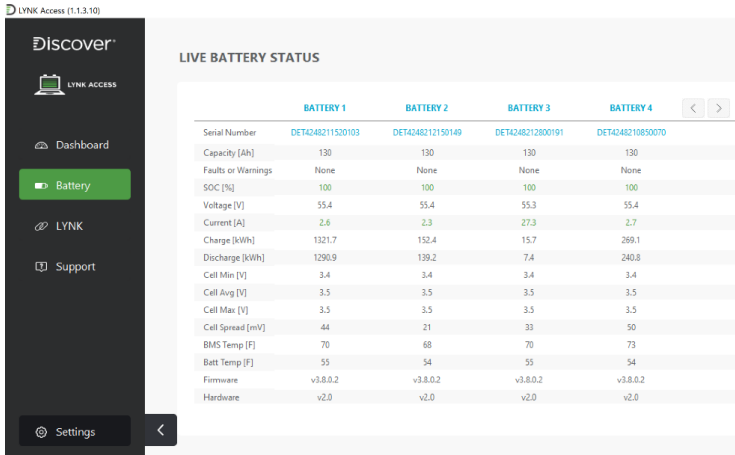

Figure 6. LYNK ACCESS - Live Battery Status

A2. Installing and Connecting LYNK II to Batteries

NOTE

- Turn OFF all devices before connecting cables.
- Do not plug an AEBus RJ45 network cable or terminator into the 10/100 Ethernet port of the LYNK II.
- Do not connect a CAT5 or higher cable from the AEBus, LYNK, or Ethernet ports of the LYNK II to a WAN or MODEM port of a network router.
- Mixing the LYNK Network with other networks may result in equipment malfunction and damage.
- Locate the LYNK II close to the batteries and avoid paths where there may be power lines or equipment that generate a lot of noise and interference.
- Unless Discover Energy Systems specifies, power electronics must not be connected directly to the LYNK or AEBus network.

Refer to the [LYNK II Installation and Operation Manual](#) (805-0033) for detailed instructions on network layouts, connections, and terminations for compatible Discover Lithium battery models. Some key reminders are provided in this manual.

- At least one battery must be connected to the LYNK Port or AEBus Port on LYNK II.
- A network of batteries will communicate as one battery.
- No more than one network of batteries may be connected to LYNK II.
- Network termination is required for the system's proper functioning - note some batteries and devices may auto-terminate.
- LYNK II requires power. There are three possible sources: a 13-90 VDC power supply, AEBus Port or LYNK Port-enabled Discover Lithium battery, or a USB device.
- Discover Lithium batteries must be set to ON to supply power and communicate data with LYNK II.

LYNK II and AES LiFePO₄ Batteries

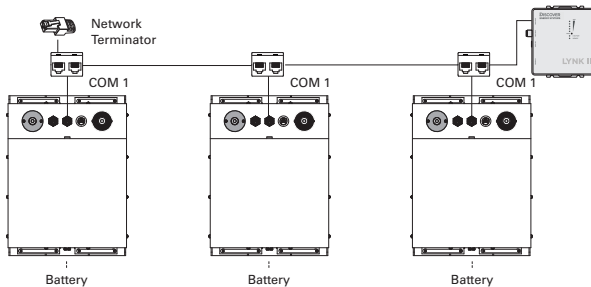

Figure 7. AEBus Network Termination

AES LiFePO₄ batteries are not internally terminated. The LYNK II communication gateway is internally terminated. When using LYNK II with an AEBus network, install a network terminator at the end opposite LYNK II.

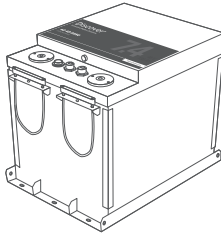

Figure 8. AES LiFePO₄ Battery

NOTE

AES LiFePO₄ 48 V batteries sold before Jan 1, 2020, will not supply power to LYNK II using the network cable connection. An external 13-90 VDC power source connected to the Phoenix 12-pin connector on LYNK II is REQUIRED for the AES LiFePO₄ batteries listed below.

- 42-48-6650 with a serial number before DET424820275xxxx

LYNK II and AES RACKMOUNT Batteries

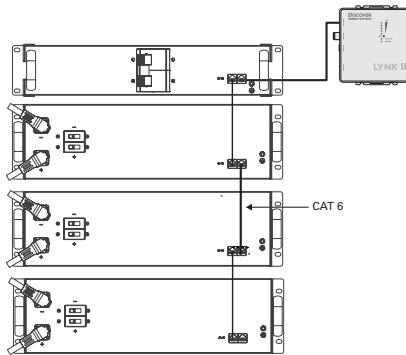

Figure 9. AES RACKMOUNT - No Extra Termination

Both LYNK II and AES RACKMOUNT Battery Modules are internally terminated. No extra termination is required.

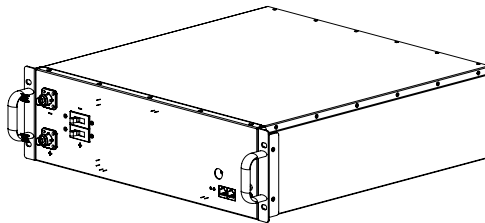

Figure 10. AES RACKMOUNT Battery Module

NOTE

[Figure 9](#) is illustrated with the optional Battery Module Combiner (BMC) connected to the battery network. Connecting the BMC enables use of its remote power off feature—turn all the batteries on or off with a single touch of the power button on the BMC.