

AES RACKMOUNT

Energy Storage System

AES RACKMOUNT Battery Cable Terminal Connector Set Manual

READ AND SAVE THESE INSTRUCTIONS

Battery Cable Terminal Connector Set 950-0054

INTRODUCTION 3

1. AUDIENCE, MESSAGES, WARNINGS, GENERAL SAFETY, PERSONAL PROTECTIVE EQUIPMENT ... 3

1.1 Audience. 3

1.2 Warning, Caution, Notice, and Note Messages 3

1.3 Warnings and General Safety 4

1.4 Safe Handling Procedures. 4

1.5 Personal Protective Equipment. 5

2. ITEMS SHIPPED IN THE BOX. 5

3. SPECIFICATIONS 5

3.1 Electrical Specifications. 5

3.2 Mechanical Specifications. 6

3.3 Ingress Protection IP67 6

4. HANDLING 7

5. THEORY OF OPERATION AND FEATURES 7

6. TOOLS 8

7. ASSEMBLY 8

8. CONNECTING TO THE BATTERY MODULE 9

8.1 Connecting to Battery Module Terminals. 9

8.2 Disconnecting from Battery Module Terminals 10

9. ROUTINE INSPECTION 10

INTRODUCTION

The AES RACKMOUNT Battery Cable Terminator Set consists of a Positive (Red) Connector and a Negative (Black) Connector. The connectors secure battery cables to the front terminals on the AES RACKMOUNT Battery Module.

1. AUDIENCE, MESSAGES, WARNINGS, GENERAL SAFETY, PERSONAL PROTECTIVE EQUIPMENT

1.1 Audience

Configuration, installations, service, and operating tasks should only be performed by qualified personnel in consultation with local authorities having jurisdiction and authorized dealers. Qualified personnel should have training, knowledge, and experience in the:

- Installation of electrical equipment
- Application of electrical codes, safety, and installation standards
- Analysis and reduction of hazards involved in performing electrical work
- Installation and configuration of batteries

1.2 Warning, Caution, Notice, and Note Messages

Messages in this manual are formatted according to this structure.

WARNING

Important information regarding hazardous conditions that may result in personal injury or death.

CAUTION

Important information regarding hazardous conditions that may result in personal injury.

NOTICE

Important information regarding conditions that may damage the equipment but not result in personal injury.

NOTE

Ad hoc information concerning important procedures and features unrelated to personal injury or equipment damage.

1.3 Warnings and General Safety

WARNING

ELECTRIC SHOCK AND FIRE HAZARD

Do not lay tools or other metal parts across battery terminals.

Failure to follow these instructions may result in death or serious injury.

CAUTION

ELECTRIC SHOCK HAZARD

- Do not touch the energized surfaces of any electrical component in the Battery Module Combiner or Battery Module system.
- Before servicing, follow all procedures to fully de-energize the Battery Module Combiner and Battery Module system.
- Follow “Safe Handling Procedures” when working with the Battery Module Combiner or Battery Module system.

Failure to follow these instructions may result in injury.

1.4 Safe Handling Procedures

Before using the Battery Cable Terminal Connector Set, read all instructions and cautionary markings on the units and all appropriate sections of this manual.

- Use personal protective equipment when working with the Battery Cable Terminal Connector.
- Dispose of or recycle a Battery Cable Terminal Connector following local regulations.
- Do not modify, re-manufacture, or attempt to insert foreign objects into the Battery Cable Terminal Connector.
- Do not immerse or expose the Battery Cable Terminal Connector to water or other liquids, fire, explosion, or other hazards.
- Use the Battery Cable Terminal Connector only with AES RACKMOUNT Battery Modules or equipment that Discover Energy Systems specifies as compatible.
- Do not lift or carry while in operation.
- Take precautions when handling electrical cables.
- Do not submerge the Battery Cable Terminal Connector.
- Do not install the Positive (Red) Battery Cable Terminal Connector on the negative battery cable.
- Do not install the Negative (Black) Battery Cable Terminal Connector on the positive battery cable.
- Do not use the Battery Cable Terminal Connector with Battery Modules or equipment that exceeds the specifications. Using Battery Modules or equipment that exceeds Battery Cable Terminal Connector specifications may present a fire risk or other hazards.

- Do not short-circuit or allow metallic conductive objects to contact cable ends and Battery Cable Terminal connectors.
- If the Battery Cable Terminal Connector is damaged, replace it.

1.5 Personal Protective Equipment

When handling or working near a battery:

- Use Personal Protective Equipment, including clothing, glasses, insulated gloves, and boots.
- Do not wear rings, watches, bracelets, or necklaces when handling or working near the battery.

2. ITEMS SHIPPED IN THE BOX

Table 2-1, AES RACKMOUNT Battery Cable Terminal Connector Set

Items	Description
1	Positive (Red) Amphenol SurLok Plus™ Connector - C10-730186-200
1	Negative (Black) Amphenol SurLok Plus™ Connector - C10-730186-100

3. SPECIFICATIONS

3.1 Electrical Specifications

The AES RACKMOUNT Battery Cable Terminal Connector Set is designed for use with the AES RACKMOUNT Battery Module Combiner and AES RACKMOUNT Battery Modules.

Table 3-1. AES RACKMOUNT Battery Cable Terminal Connector Electrical Specifications

Electrical Specifications	AES RACKMOUNT Battery Cable Terminal Connector
Operating Temperature	-40°C (-40°F) to 125°C (257°F)
Current Rating	120 A max
Operating Voltage	1000 Vdc
Dielectric Withstanding Voltage	3000 Vdc

3.2 Mechanical Specifications

Table 3-2. AES RACKMOUNT Battery Cable Terminal Connector Mechanical Specifications

Mechanical Specifications	AES RACKMOUNT Battery Cable Terminal Connector
Height	22.6 mm (0.89 in)
Width	18 mm (0.71 in)
Length	55.1 mm (2.17 in)
Cable Acceptance	25 mm ² (4 AWG) – 26.5 mm ² (3 AWG)
IP Rating	IP67

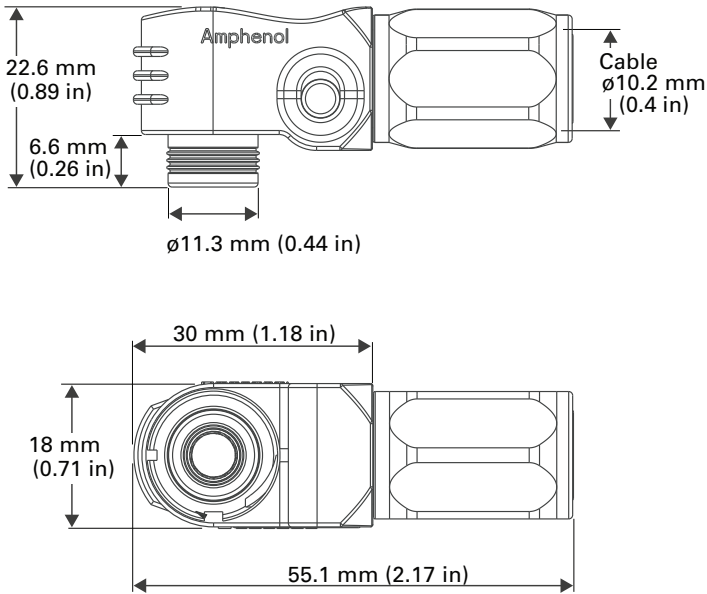

Figure 1. AES RACKMOUNT Battery Cable Terminal Connector Dimensions

3.3 Ingress Protection IP67

Ingress protection rates the degree of protection provided by mechanical casings and electrical enclosures against intrusion, dust, accidental contact, and water under specified conditions. The IP67 rating indicates that the product, when connected to the terminal pin, provides protection against dust and airborne particles as well as protection against water and liquids up to a depth of 1 meter.

IP codes guide suitability for use under different environmental conditions. IP ratings do not indicate fitness for purpose or confer a performance guarantee.

4. HANDLING

Before handling

- Keep the Battery Cable Terminal Connector away from water, heat, and fire.
- De-energize all sources of power before handling a Battery Cable Terminal Connector.
- De-energize all sources of power before disconnecting a Battery Cable Terminal Connector.
- Protect the Battery Cable Terminal Connector from short-circuiting and touch.
- Do not lift or carry equipment by the Battery Cable Terminal Connector.

5. THEORY OF OPERATION AND FEATURES

On the Battery Cable Terminal Connector, turn the Back Shell counterclockwise to screw it off and reveal the Grommet inside. The battery cable is passed through the Back Shell and Grommet, and into the drum, and the cable is secured by crimping the drum and cable together. Put the Connector, Grommet, and Back Shell back together by screwing the Back Shell back onto the Connector to encapsulate the cable after crimping. The assembled Battery Cable Terminal Connector connects to the male receiving terminal pin on the faceplate of the AES RACKMOUNT Battery Module when you push the connector onto the receiving pin.

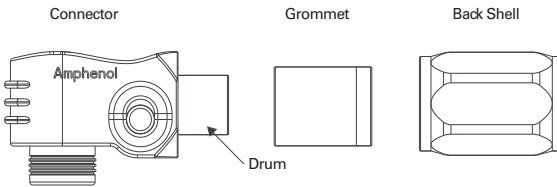

Figure 2. Battery Cable Terminal Connector parts

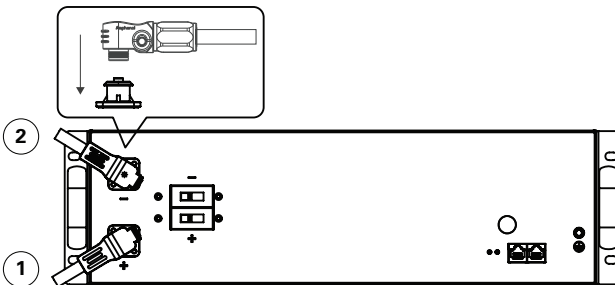

Figure 3. Battery Cable Terminal Connectors Mated with AES RACKMOUNT Battery Module

6. TOOLS

- Cable cutting tool
- Hexagonal manual hydraulic crimping tool with 25 mm² die (suitable for 26.5 mm², 3 AWG cable)
- True RMS Multimeter
- Personal protective equipment

7. ASSEMBLY

The AES RACKMOUNT Battery Cable Terminal Connector consists of three pieces: Connector, Grommet, and Back Shell.

The battery cable is passed through the Back Shell and Grommet, and into the Drum, and the cable is secured by crimping the drum and cable together. Put the Connector, Grommet, and Back Shell together by screwing the Back Shell back onto the Connector to encapsulate the cable after crimping.

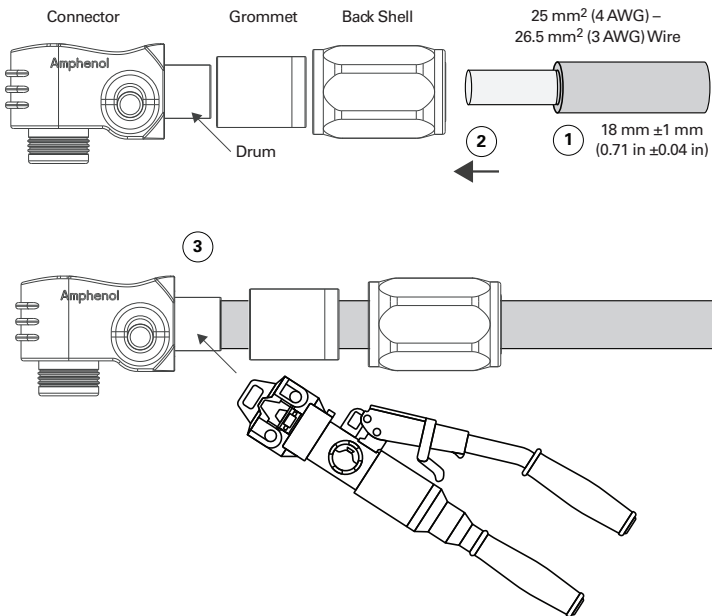

Figure 4. AES RACKMOUNT Battery Cable Terminal Connector Assembly

1. Cut the battery cable to the length required and strip 18.0 mm ±1.0 mm (0.71 in ±0.04 in) of insulation off the end of the cable.
2. Pass the cable through the Back Shell and Grommet, and insert the bare cable into the drum of the Connector.
 - a. Ensure the chamfer of the Grommet is pointed towards the Back Shell.
 - b. Line the cable up so the insulation is right beside the drum of the Connector.
3. Using a manual hexagonal hydraulic crimping tool, crimp the drum of the Connector to the battery cable.

- a. Compress the crimp height to 7.5 mm +/- 0.2 mm (0.295 in ±0.008 in) and a minimum cable pullout force of 1200 N (270 lb).
4. Push the Grommet and Back Shell up against the Connector, and twist to screw the Back Shell onto the Connector.

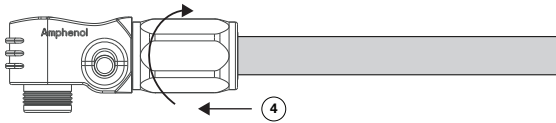

Figure 5. AES RACKMOUNT Battery Cable Terminal Connector

8. CONNECTING TO THE BATTERY MODULE

⚠ WARNING

ELECTRIC SHOCK AND FIRE HAZARD

- Always assume the AES RACKMOUNT Battery Module Combiner is energized, even if the At-a-glance LED shows that the AES RACKMOUNT Battery Modules are OFF.
- Even if the AES RACKMOUNT Battery Module Combiner LED is OFF, the combiner may be energized by power from the Power Conversion System (inverter-charger / MPPT controller).
- Verify the terminal voltage with a voltmeter before handling any components in the Energy Storage System.

Failure to follow these instructions may result in death or serious injury.

8.1 Connecting to Battery Module Terminals

The AES RACKMOUNT Battery Cable Terminal Connector mates with the receiving pin of the male terminal on the faceplate of the AES RACKMOUNT Battery Module.

1. De-energize all AES RACKMOUNT Battery Modules and the AES RACKMOUNT Battery Module Combiner.
2. Attach the red, positive (+) connector to the red, positive (+) terminal on the Battery Module and push to lock the Connector to the terminal.
3. Attach the black, negative (-) connector to the black, negative (-) terminal on the Battery Module and push to lock the Connector to the terminal.

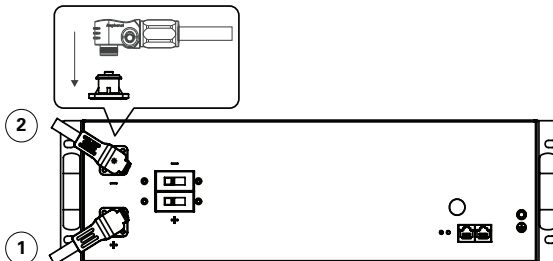

Figure 6. Connection with the Battery Module

8.2 Disconnecting from Battery Module Terminals

1. De-energize all AES RACKMOUNT Battery Modules and the AES RACKMOUNT Battery Module Combiner.
2. Detach the red, positive (+) connector from the positive (+) terminals on the Battery Module by holding down the button on the side of the Connector and pulling it away from the Battery Module.

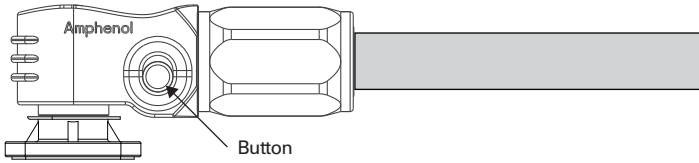

Figure 7. AES RACKMOUNT Battery Cable Terminal Connector Disconnection

3. Detach the black, negative (-) connector from the black, negative (-) terminal on the Battery Module by holding down the button on the side of the Connector and pulling it away from the Battery Module.

9. ROUTINE INSPECTION

Periodically inspect the Battery Cable Terminal Connector:

1. Ensure that all terminal connections are secure and tight.
2. Ensure that the contact location is clean and free of debris.
3. Inspect the Battery Cable Terminal Connector covers for cracks.
4. Replace any damaged Battery Cable Terminal Connectors.
5. Replace any cracked, frayed, or damaged cables.